

（标准品）氧化锌压敏电阻器规格书

特点

- 电阻器工作电压范围从 18V 到 1100V。
- 工作温度： -40℃~ +105℃
- 储存温度： 15℃~35℃

用途

- 晶体管，IC，可控硅和半导体开关元件以及各种电子，电器设备的过压保护。
- 家用电器的浪涌吸收和过压保护。
- 工业电器浪涌吸收。
- 静电放电和噪音信号消除。
- 继电器和电磁阀的浪涌吸收。
- 漏电开关的过电压保护。
- 电话机程控交换机及通讯设备的防雷及过压保护。

安规认证

国家	认证组织	标准号	证书号
中国		CQC GB/T10193 GB/T10194	5D: CQC07001020534
			7D: CQC07001020533
			10D: CQC07001020532
			14D: CQC07001020531
			20D: CQC07001020530
美国/加拿大		UL UL1449	E330837
德国		VDE IEC61051	40023049

料号编码原则

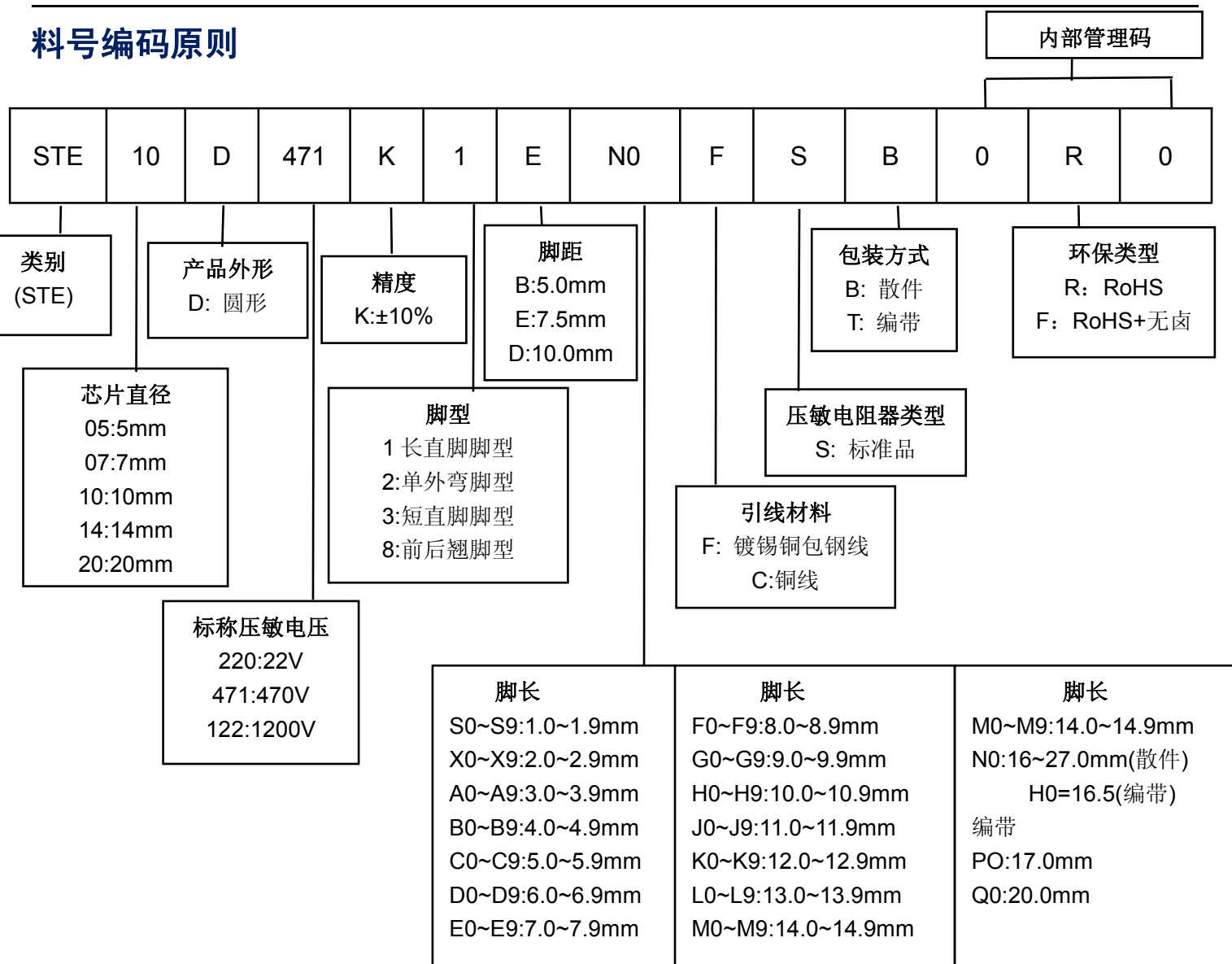

基本特性

5D-系列

规格	最大连续工作电压		压敏电压	最大限制电压		最大峰值电流 (8/20μs)		最大能量 (10/1000μs) (J)	额定功率 (W)	静电容量 (参考值) 1KHz (pF)
	AC _{rms} (V)	DC _{rms} (V)		V _{0.1mA} (V)	VC (V)	IP (A)	1 pulse (A)			
STE-05D180K	11	14	18(15-21.6)	40	1	100	50	0.4	0.01	1400
STE-05D220K	14	18	22(19.5-26)	48	1	100	50	0.5	0.01	1150
STE-05D270K	17	22	27(24-31)	60	1	100	50	0.6	0.01	930
STE-05D330K	20	26	33(29.5-36.5)	73	1	100	50	0.8	0.01	760
STE-05D390K	25	31	39(35-43)	80	1	100	50	0.9	0.01	640
STE-05D470K	30	38	47(42-52)	104	1	100	50	1.1	0.01	530

规格	最大连续工作电压		压敏电压 $V_{0.1mA}$ (V)	最大限制电压			最大峰值电流 (8/20 μ s)		最大能量 (10/1000 μ s) (J)	额定功率 (W)	静电容量 (参考值) 1KHz (pF)
	AC _{rms} (V)	DC _{rms} (V)		VC (V)	IP (A)	1 pulse (A)	2 pulse (A)				
STE-05D560K	35	45	56(50-62)	123	1	100	50	1.3	0.01	450	
STE-05D680K	40	56	68(61-75)	145	1	100	50	1.6	0.01	370	
STE-05D820K	50	65	82(74-90)	150	5	400	200	2.5	0.1	300	
STE-05D101K	60	85	100(90-110)	175	5	400	200	3.0	0.1	250	
STE-05D121K	75	100	120(108-132)	210	5	400	200	3.5	0.1	210	
STE-05D151K	95	125	150(135-165)	260	5	400	200	4.5	0.1	165	
STE-05D181K	115	150	180(162-198)	320	5	400	200	5.9	0.1	140	
STE-05D201K	130	170	200(180-220)	355	5	400	200	6.5	0.1	125	
STE-05D221K	140	180	220(198-242)	380	5	400	200	7.0	0.1	110	
STE-05D241K	150	200	240(216-264)	415	5	400	200	8.0	0.1	100	
STE-05D271K	175	225	270(243-297)	475	5	400	200	8.5	0.1	95	
STE-05D301K	190	250	300(270-330)	520	5	400	200	9.0	0.1	85	
STE-05D331K	210	275	330(297-363)	570	5	400	200	9.5	0.1	75	
STE-05D361K	230	300	360(324-396)	620	5	400	200	10.0	0.1	70	
STE-05D391K	250	320	390(351-429)	675	5	400	200	12.0	0.1	65	
STE-05D431K	275	350	430(387-473)	745	5	400	200	13.0	0.1	60	
STE-05D471K	300	385	470(423-517)	810	5	400	200	15.0	0.1	55	
STE-05D511K	320	415	510(459-561)	845	5	400	200	16.0	0.1	50	
STE-05D561K	350	460	560(504-616)	920	5	400	200	16.8	0.1	45	
STE-05D621K	385	505	620(558-682)	1025	5	400	200	17.7	0.1	40	
STE-05D681K	420	560	680(612-748)	1120	5	400	200	19.4	0.1	38	

7D-系列

规格	最大连续工作电压		压敏电压 V_{1mA} (V)	最大限制电压			最大峰值电流 (8/20 μ s)		最大能量 (10/1000 μ s) (J)	额定功率 (W)	静电容量 (参考值) 1KHz (pF)
	AC _{rms} (V)	DC _{rms} (V)		VC (V)	IP (A)	1 pulse (A)	2 pulse (A)				
STE-07D180K	11	14	18(15-21.6)	36	2.5	250	125	0.9	0.02	2800	
STE-07D220K	14	18	22(19.5-26)	43	2.5	250	125	1.1	0.02	2300	
STE-07D270K	17	22	27(24-31)	53	2.5	250	125	1.4	0.02	1800	
STE-07D330K	20	26	33(29.5-36.5)	65	2.5	250	125	1.7	0.02	1500	

规格	最大连续工作电压		压敏电压	最大限制电压			最大峰值电流 (8/20μs)		最大能量 (10/1000μs)	额定功率	静电容量 (参考值)
	AC _{rms} (V)	DC _{rms} (V)		V _{1mA} (V)	VC (V)	IP (A)	1 pulse (A)	2 pulse (A)			
STE-07D390K	25	31	39(35-43)	77	2.5	250	125	2.1	0.02	1300	
STE-07D470K	30	38	47(42-52)	93	2.5	250	125	2.5	0.02	1100	
STE-07D560K	35	45	56(50-62)	110	2.5	250	125	3.1	0.02	890	
STE-07D680K	40	56	68(61-75)	135	2.5	250	125	3.6	0.02	740	
STE-07D820K	50	65	82(74-90)	135	10	1200	600	5.5	0.25	810	
STE-07D101K	60	85	100(90-110)	165	10	1200	600	6.5	0.25	700	
STE-07D121K	75	100	120(108-132)	200	10	1200	600	7.8	0.25	590	
STE-07D151K	95	125	150(135-165)	250	10	1200	600	9.7	0.25	500	
STE-07D181K	115	150	180(162-198)	300	10	1200	600	11.7	0.25	280	
STE-07D201K	130	170	200(180-220)	340	10	1200	600	13.0	0.25	200	
STE-07D221K	140	180	220(198-242)	360	10	1200	600	14.0	0.25	190	
STE-07D241K	150	200	240(216-264)	395	10	1200	600	15.0	0.25	170	
STE-07D271K	175	225	270(243-297)	455	10	1200	600	18.0	0.25	150	
STE-07D301K	190	250	300(270-330)	500	10	1200	600	20.0	0.25	140	
STE-07D331K	210	275	330(297-363)	550	10	1200	600	23.0	0.25	130	
STE-07D361K	230	300	360(324-396)	595	10	1200	600	24.0	0.25	130	
STE-07D391K	250	320	390(351-429)	650	10	1200	600	26.0	0.25	130	
STE-07D431K	275	350	430(387-473)	710	10	1200	600	28.0	0.25	120	
STE-07D471K	300	385	470(423-517)	775	10	1200	600	29.0	0.25	100	
STE-07D511K	320	415	510(459-561)	845	10	1200	600	31.0	0.25	90	
STE-07D561K	350	460	560(504-616)	925	10	1200	600	35.0	0.25	90	
STE-07D621K	385	505	620(558-682)	1025	10	1200	600	38.0	0.25	80	
STE-07D681K	420	560	680(612-748)	1120	10	1200	600	42.0	0.25	75	

10D-系列

规格	最大连续工作电压		压敏电压	最大限制电压			最大峰值电流 (8/20μs)		最大能量 (10/1000μs)	额定功率	静电容量 (参考值)
	AC _{rms} (V)	DC _{rms} (V)		V _{1mA} (V)	VC (V)	IP (A)	1 pulse (A)	2 pulse (A)			
STE-10D180K	11	14	18(15-21.6)	36	5	500	250	2.1	0.05	5600	
STE-10D220K	14	18	22(19.5-26)	43	5	500	250	2.5	0.05	4500	

规格	最大连续工作电压		压敏电压 V_{1mA} (V)	最大限制电压			最大峰值电流 (8/20 μ s)		最大能量 (10/1000 μ s) (J)	额定功率 (W)	静电容量 (参考值) 1KHz (pF)
	AC _{rms} (V)	DC _{rms} (V)		VC (V)	IP (A)	1 pulse (A)	2 pulse (A)				
STE-10D270K	17	22	27(24-31)	53	5	500	250	3.0	0.05	3700	
STE-10D330K	20	26	33(29.5-36.5)	65	5	500	250	4.0	0.05	3000	
STE-10D390K	25	31	39(35-43)	77	5	500	250	4.6	0.05	2400	
STE-10D470K	30	38	47(42-52)	93	5	500	250	5.5	0.05	2100	
STE-10D560K	35	45	56(50-62)	110	5	500	250	7.0	0.05	1800	
STE-10D680K	40	56	68(61-75)	135	5	500	250	8.2	0.05	1500	
STE-10D820K	50	65	82(74-90)	135	25	2500	1250	12.0	0.4	2000	
STE-10D101K	60	85	100(90-110)	165	25	2500	1250	15.0	0.4	1700	
STE-10D121K	75	100	120(108-132)	200	25	2500	1250	18.0	0.4	1400	
STE-10D151K	95	125	150(135-165)	250	25	2500	1250	22.0	0.4	1100	
STE-10D181K	115	150	180(162-198)	300	25	2500	1250	27.0	0.4	560	
STE-10D201K	130	170	200(180-220)	340	25	2500	1250	30.0	0.4	430	
STE-10D221K	140	180	220(198-242)	360	25	2500	1250	32.0	0.4	410	
STE-10D241K	150	200	240(216-264)	395	25	2500	1250	35.0	0.4	380	
STE-10D271K	175	225	270(243-297)	455	25	2500	1250	37.0	0.4	350	
STE-10D301K	190	250	300(270-330)	500	25	2500	1250	40.0	0.4	330	
STE-10D331K	210	275	330(297-363)	550	25	2500	1250	43.0	0.4	300	
STE-10D361K	230	300	360(324-396)	595	25	2500	1250	47.0	0.4	300	
STE-10D391K	250	320	390(351-429)	650	25	2500	1250	60.0	0.4	300	
STE-10D431K	275	350	430(387-473)	710	25	2500	1250	65.0	0.4	270	
STE-10D471K	300	385	470(423-517)	775	25	2500	1250	67.0	0.4	230	
STE-10D511K	320	415	510(459-561)	845	25	2500	1250	69.0	0.4	210	
STE-10D561K	350	460	560(504-616)	925	25	2500	1250	70.0	0.4	180	
STE-10D621K	385	505	620(558-682)	1025	25	2500	1250	72.0	0.4	190	
STE-10D681K	420	560	680(612-748)	1120	25	2500	1250	75.0	0.4	170	
STE-10D751K	460	615	750(675-825)	1240	25	2500	1250	77.0	0.4	160	
STE-10D781K	485	640	780(702-858)	1290	25	2500	1250	80.0	0.4	125	
STE-10D821K	510	670	820(738-902)	1355	25	2500	1250	85.0	0.4	140	
STE-10D911K	550	745	910(819-1001)	1500	25	2500	1250	93.0	0.4	120	
STE-10D102K	625	825	1000(900-1100)	1650	25	2500	1250	102.0	0.4	110	
STE-10D112K	680	895	1100(990-1210)	1815	25	2500	1250	115.0	0.4	90	

14D-系列

规格	最大连续工作电压		压敏电压 V_{1mA} (V)	最大限制电压		最大峰值电流 (8/20 μ s)		最大能量 (10/1000 μ s) (J)	额定功率 (W)	静电容量 (参考值) 1KHz (pF)
	AC _{rms} (V)	DC _{rms} (V)		VC (V)	IP (A)	1 pulse (A)	2 pulse (A)			
STE-14D180K	11	14	18(15-21.6)	36	10	1000	500	4.0	0.1	11100
STE-14D220K	14	18	22(19.5-26)	43	10	1000	500	5.0	0.1	9100
STE-14D270K	17	22	27(24-31)	53	10	1000	500	6.0	0.1	7400
STE-14D330K	20	26	33(29.5-36.5)	65	10	1000	500	7.5	0.1	6100
STE-14D390K	25	31	39(35-43)	77	10	1000	500	8.6	0.1	5100
STE-14D470K	30	38	47(42-52)	93	10	1000	500	10.0	0.1	4300
STE-14D560K	35	45	56(50-62)	110	10	1000	500	11.0	0.1	3600
STE-14D680K	40	56	68(61-75)	135	10	1000	500	14.0	0.1	2900
STE-14D820K	50	65	82(74-90)	135	50	4500	2500	22.0	0.6	3700
STE-14D101K	60	85	100(90-110)	165	50	4500	2500	28.0	0.6	3200
STE-14D121K	75	100	120(108-132)	200	50	4500	2500	32.0	0.6	2700
STE-14D151K	95	125	150(135-165)	250	50	4500	2500	40.0	0.6	2200
STE-14D181K	115	150	180(162-198)	300	50	4500	2500	50.0	0.6	1100
STE-14D201K	130	170	200(180-220)	340	50	4500	2500	57.0	0.6	770
STE-14D221K	140	180	220(198-242)	360	50	4500	2500	60.0	0.6	740
STE-14D241K	150	200	240(216-264)	395	50	4500	2500	63.0	0.6	700
STE-14D271K	175	225	270(243-297)	455	50	4500	2500	70.0	0.6	640
STE-14D301K	190	250	300(270-330)	500	50	4500	2500	77.0	0.6	670
STE-14D331K	210	275	330(297-363)	550	50	4500	2500	85.0	0.6	580
STE-14D361K	230	300	360(324-396)	595	50	4500	2500	93.0	0.6	540
STE-14D391K	250	320	390(351-429)	650	50	4500	2500	100	0.6	500
STE-14D431K	275	350	430(387-473)	710	50	4500	2500	115	0.6	450
STE-14D471K	300	385	470(423-517)	775	50	4500	2500	118	0.6	400
STE-14D511K	320	415	510(459-561)	845	50	4500	2500	121	0.6	350
STE-14D561K	350	460	560(504-616)	925	50	4500	2500	125	0.6	360
STE-14D621K	385	505	620(558-682)	1025	50	4500	2500	128	0.6	330
STE-14D681K	420	560	680(612-748)	1120	50	4500	2500	130	0.6	320
STE-14D751K	460	615	750(675-825)	1240	50	4500	2500	143	0.6	310
STE-14D781K	485	640	780(702-858)	1290	50	4500	2500	148	0.6	260
STE-14D821K	510	670	820(738-902)	1355	50	4500	2500	157	0.6	280

规格	最大连续工作电压		压敏电压	最大限制电压			最大峰值电流 (8/20 μ s)		最大能量 (10/1000 μ s) (J)	额定功率 (W)	静电容量 (参考值) 1KHz (pF)
	AC _{rms} (V)	DC _{rms} (V)		V _{1mA} (V)	VC (V)	IP (A)	1 pulse (A)	2 pulse (A)			
STE-14D911K	550	745	910(819-1001)	1500	50	4500	2500	175	0.6	250	
STE-14D102K	625	825	1000(900-1100)	1650	50	4500	2500	190	0.6	230	
STE-14D112K	680	895	1100(990-1210)	1815	50	4500	2500	213	0.6	180	

20D-系列

规格	最大连续工作电压		压敏电压	最大限制电压			最大峰值电流 (8/20 μ s)		最大能量 (10/1000 μ s) (J)	额定功率 (W)	静电容量 (参考值) 1KHz (pF)
	AC _{rms} (V)	DC _{rms} (V)		V _{1mA} (V)	VC (V)	IP (A)	1 pulse (A)	2 pulse (A)			
STE-20D180K	11	14	18(15-21.6)	36	20	2000	1000	11	0.2	28500	
STE-20D220K	14	18	22(19.5-26)	43	20	2000	1000	14	0.2	18500	
STE-20D270K	17	22	27(24-31)	53	20	2000	1000	16	0.2	13000	
STE-20D330K	20	26	33(29.5-36.5)	65	20	2000	1000	23	0.2	11500	
STE-20D390K	25	31	39(35-43)	77	20	2000	1000	26	0.2	8500	
STE-20D470K	30	38	47(42-52)	93	20	2000	1000	30	0.2	7400	
STE-20D560K	35	45	56(50-62)	110	20	2000	1000	38	0.2	6500	
STE-20D680K	40	56	68(61-75)	135	20	2000	1000	41	0.2	5800	
STE-20D820K	50	65	82(74-90)	135	100	6500	4500	45	1.0	7500	
STE-20D101K	60	85	100(90-110)	165	100	6500	4500	50	1.0	6500	
STE-20D121K	75	100	120(108-132)	200	100	6500	4500	55	1.0	5500	
STE-20D151K	95	125	150(135-165)	250	100	6500	4500	70	1.0	4500	
STE-20D181K	115	150	180(162-198)	300	100	6500	4500	85	1.0	2200	
STE-20D201K	130	170	200(180-220)	340	100	6500	4500	95	1.0	1700	
STE-20D221K	140	180	220(198-242)	360	100	6500	4500	100	1.0	1600	
STE-20D241K	150	200	240(216-264)	395	100	6500	4500	108	1.0	1500	
STE-20D271K	175	225	270(243-297)	455	100	6500	4500	127	1.0	1300	
STE-20D301K	190	250	300(270-330)	500	100	6500	4500	136	1.0	1300	
STE-20D331K	210	275	330(297-363)	550	100	6500	4500	150	1.0	1100	
STE-20D361K	230	300	360(324-396)	595	100	6500	4500	163	1.0	1100	
STE-20D391K	250	320	390(351-429)	650	100	6500	4500	180	1.0	1100	
STE-20D431K	275	350	430(387-473)	710	100	6500	4500	190	1.0	1000	

规格	最大连续工作电压		压敏电压	最大限制电压		最大峰值电流 (8/20μs)		最大能量 (10/1000μs)	额定功率	静电容量 (参考值)
	AC _{rms} (V)	DC _{rms} (V)		V _{1mA} (V)	VC (V)	IP (A)	1 pulse (A)			
STE-20D471K	300	385	470(423-517)	775	100	6500	4500	204	1.0	900
STE-20D511K	320	415	510(459-561)	845	100	6500	4500	210	1.0	800
STE-20D561K	350	460	560(504-616)	925	100	6500	4500	215	1.0	710
STE-20D621K	385	505	620(558-682)	1025	100	6500	4500	224	1.0	700
STE-20D681K	420	560	680(612-748)	1120	100	6500	4500	230	1.0	650
STE-20D751K	460	615	750(675-825)	1240	100	6500	4500	255	1.0	600
STE-20D781K	485	640	780(702-858)	1290	100	6500	4500	265	1.0	510
STE-20D821K	510	670	820(738-902)	1355	100	6500	4500	282	1.0	530
STE-20D911K	550	745	910(819-1001)	1500	100	6500	4500	310	1.0	500
STE-20D102K	625	825	1000(900-1100)	1650	100	6500	4500	342	1.0	450
STE-20D112K	680	895	1100(990-1210)	1815	100	6500	4500	383	1.0	360

外形尺寸 (mm)和安规认证

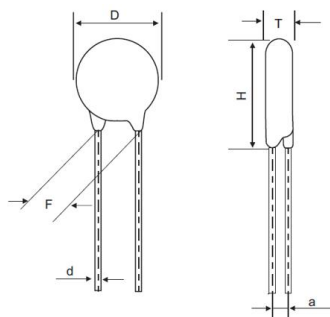

5D-系列

规格	尺寸 (mm)				安规认证			
	D Max.	T Max.	F±0.8	d±0.05	CQC	VDE	UL (美国)	cUL (加拿大)
STE-05D180K	7.5	3.0	5.0	0.5			√	√
STE-05D220K	7.5	3.5	5.0	0.5			√	√
STE-05D270K	7.5	3.5	5.0	0.5			√	√
STE-05D330K	7.5	3.5	5.0	0.5			√	√
STE-05D390K	7.5	3.5	5.0	0.5			√	√
STE-05D470K	7.5	4.0	5.0	0.5				
STE-05D560K	7.5	4.0	5.0	0.5				

规格	尺寸 (mm)				安规认证			
	D Max.	T Max.	F±0.8	d±0.05	CQC	VDE	UL	cUL

							(美国)	(加拿大)
STE-05D680K	7.5	4.5	5.0	0.5				
STE-05D820K	7.5	3.5	5.0	0.5	√		√	√
STE-05D101K	7.5	3.5	5.0	0.5	√		√	√
STE-05D121K	7.5	3.5	5.0	0.5	√		√	√
STE-05D151K	7.5	3.5	5.0	0.5	√		√	√
STE-05D181K	7.5	4.0	5.0	0.5	√		√	√
STE-05D201K	7.5	4.0	5.0	0.5	√		√	√
STE-05D221K	7.5	4.0	5.0	0.5	√		√	
STE-05D241K	7.5	4.0	5.0	0.5	√		√	
STE-05D271K	7.5	4.0	5.0	0.5	√		√	
STE-05D301K	7.5	4.5	5.0	0.5	√		√	
STE-05D331K	7.5	4.5	5.0	0.5	√		√	
STE-05D361K	7.5	4.5	5.0	0.5	√		√	
STE-05D391K	7.5	5.0	5.0	0.5	√		√	
STE-05D431K	7.5	4.5	5.0	0.5	√		√	
STE-05D471K	7.5	4.5	5.0	0.5	√		√	
STE-05D511K	7.5	4.5	5.0	0.5	√		√	
STE-05D561K	7.5	4.5	5.0	0.5	√		√	
STE-05D621K	7.5	5.0	5.0	0.5				
STE-05D681K	7.5	5.0	5.0	0.5				

7D-系列

规格	尺寸 (mm)				安规认证			
	D Max.	T Max.	F±0.8	d±0.05	CQC	VDE	UL (美国)	cUL (加拿大)
STE-07D180K	9.0	3.5	5.0	0.5			√	√
STE-07D220K	9.0	3.5	5.0	0.5			√	√
STE-07D270K	9.0	3.5	5.0	0.5			√	√
STE-07D330K	9.0	3.5	5.0	0.5			√	√
STE-07D390K	9.0	3.5	5.0	0.5			√	√
STE-07D470K	9.0	4.0	5.0	0.5			√	√
STE-07D560K	9.0	4.0	5.0	0.5			√	√
STE-07D680K	9.0	4.5	5.0	0.5			√	√
STE-07D820K	9.0	3.5	5.0	0.5	√	√	√	√
STE-07D101K	9.0	3.5	5.0	0.5	√	√	√	√
STE-07D121K	9.0	3.5	5.0	0.5	√	√	√	√
STE-07D151K	9.0	3.5	5.0	0.5	√	√	√	√
规格	尺寸 (mm)				安规认证			

	D Max.	T Max.	F±0.8	d±0.05	CQC	VDE	UL (美国)	cUL (加拿大)
STE-07D181K	9.0	4.0	5.0	0.5	√	√	√	√
STE-07D201K	9.0	4.0	5.0	0.5	√	√	√	√
STE-07D221K	9.0	4.5	5.0	0.5	√	√	√	√
STE-07D241K	9.0	4.0	5.0	0.5	√	√	√	√
STE-07D271K	9.0	4.0	5.0	0.5	√	√	√	√
STE-07D301K	9.0	4.5	5.0	0.5	√	√	√	√
STE-07D331K	9.0	4.5	5.0	0.5	√	√	√	√
STE-07D361K	9.0	4.5	5.0	0.5	√	√	√	√
STE-07D391K	9.0	5.0	5.0	0.5	√	√	√	√
STE-07D431K	9.0	4.5	5.0	0.5	√	√	√	√
STE-07D471K	9.0	4.5	5.0	0.5	√	√	√	√
STE-07D511K	9.0	4.5	5.0	0.5	√	√	√	√
STE-07D561K	9.0	4.5	5.0	0.5	√	√	√	√
STE-07D621K	9.0	5.0	5.0	0.5	√	√	√	√
STE-07D681K	9.0	5.0	5.0	0.5	√	√	√	√

10D-系列

规格	尺寸 (mm)				安规认证			
	D Max.	T Max.	F±0.8	d±0.05	CQC	VDE	UL (美国)	cUL (加拿大)
STE-10D180K	12.5	3.5	7.5	0.7			√	√
STE-10D220K	12.5	3.5	7.5	0.7			√	√
STE-10D270K	12.5	4.0	7.5	0.7			√	√
STE-10D330K	12.5	4.0	7.5	0.7			√	√
STE-10D390K	12.5	4.0	7.5	0.7			√	√
STE-10D470K	12.5	4.0	7.5	0.7			√	√
STE-10D560K	12.5	4.5	7.5	0.7			√	√
STE-10D680K	12.5	5.0	7.5	0.7			√	√
STE-10D820K	12.5	4.0	7.5	0.7	√	√	√	√
STE-10D101K	12.5	4.0	7.5	0.7	√	√	√	√
STE-10D121K	12.5	4.0	7.5	0.7	√	√	√	√
STE-10D151K	12.5	4.5	7.5	0.7	√	√	√	√
STE-10D181K	12.5	4.5	7.5	0.7	√	√	√	√
STE-10D201K	12.5	4.5	7.5	0.7	√	√	√	√
STE-10D221K	12.5	4.5	7.5	0.7	√	√	√	√
STE-10D241K	12.5	4.5	7.5	0.7	√	√	√	√

规格	尺寸 (mm)	安规认证
----	---------	------

	D Max.	T Max.	F±0.8	d±0.05	CQC	VDE	UL (美国)	cUL (加拿大)
STE-10D271K	12.5	4.5	7.5	0.7	√	√	√	√
STE-10D301K	12.5	5.0	7.5	0.7	√	√	√	√
STE-10D331K	12.5	5.0	7.5	0.7	√	√	√	√
STE-10D361K	12.5	5.0	7.5	0.7	√	√	√	√
STE-10D391K	12.5	5.0	7.5	0.7	√	√	√	√
STE-10D431K	12.5	5.0	7.5	0.7	√	√	√	√
STE-10D471K	12.5	5.0	7.5	0.7	√	√	√	√
STE-10D511K	12.5	5.0	7.5	0.7	√	√	√	√
STE-10D561K	12.5	5.5	7.5	0.7	√	√	√	√
STE-10D621K	12.5	5.5	7.5	0.7	√	√	√	√
STE-10D681K	12.5	5.5	7.5	0.7	√	√	√	√
STE-10D751K	12.5	6.0	7.5	0.7	√	√	√	√
STE-10D781K	12.5	6.0	7.5	0.7			√	√
STE-10D821K	12.5	6.0	7.5	0.7	√	√	√	√
STE-10D911K	12.5	6.5	7.5	0.7	√	√	√	√
STE-10D102K	12.5	7.0	7.5	0.7	√	√	√	√
STE-10D112K	12.5	7.5	7.5	0.7	√		√	√

14D-系列

规格	尺寸 (mm)				安规认证			
	D Max.	T Max.	F±0.8	d±0.05	CQC	VDE	UL (美国)	cUL (加拿大)
STE-14D180K	16.5	3.5	7.5	0.7			√	√
STE-14D220K	16.5	3.5	7.5	0.7			√	√
STE-14D270K	16.5	4.0	7.5	0.7			√	√
STE-14D330K	16.5	4.0	7.5	0.7			√	√
STE-14D390K	16.5	4.0	7.5	0.7			√	√
STE-14D470K	16.5	4.0	7.5	0.7			√	√
STE-14D560K	16.5	4.5	7.5	0.7			√	√
STE-14D680K	16.5	5.0	7.5	0.7			√	√
STE-14D820K	16.5	4.0	7.5	0.7	√	√	√	√
STE-14D101K	16.5	4.0	7.5	0.7	√	√	√	√
STE-14D121K	16.5	4.0	7.5	0.7	√	√	√	√
STE-14D151K	16.5	4.5	7.5	0.7	√	√	√	√
STE-14D181K	16.5	4.5	7.5	0.7	√	√	√	√
STE-14D201K	16.5	4.5	7.5	0.7	√	√	√	√
规格	尺寸 (mm)				安规认证			

	D Max.	T Max.	F±0.8	d±0.05	CQC	VDE	UL (美国)	cUL (加拿大)
STE-14D221K	16.5	4.5	7.5	0.7	√	√	√	√
STE-14D241K	16.5	4.5	7.5	0.7	√	√	√	√
STE-14D271K	16.5	4.5	7.5	0.7	√	√	√	√
STE-14D301K	16.5	5.0	7.5	0.7	√	√	√	√
STE-14D331K	16.5	5.0	7.5	0.7	√	√	√	√
STE-14D361K	16.5	5.0	7.5	0.7	√	√	√	√
STE-14D391K	16.5	5.0	7.5	0.7	√	√	√	√
STE-14D431K	16.5	5.0	7.5	0.7	√	√	√	√
STE-14D471K	16.5	5.0	7.5	0.7	√	√	√	√
STE-14D511K	16.5	5.0	7.5	0.7	√	√	√	√
STE-14D561K	16.5	5.5	7.5	0.7	√	√	√	√
STE-14D621K	16.5	5.5	7.5	0.7	√	√	√	√
STE-14D681K	16.5	5.5	7.5	0.7	√	√	√	√
STE-14D751K	16.5	6.0	7.5	0.7	√	√	√	√
STE-14D781K	16.5	6.0	7.5	0.7			√	√
STE-14D821K	16.5	6.0	7.5	0.7	√	√	√	√
STE-14D911K	16.5	6.5	7.5	0.7	√	√	√	√
STE-14D102K	16.5	7.0	7.5	0.7	√	√	√	√
STE-14D112K	16.5	7.5	7.5	0.7	√		√	√

20D-系列

规格	尺寸 (mm)					安规认证			
	D Max.	T Max.	F±0.8	d±0.05		CQC	VDE	UL (美国)	cUL (加拿大)
				直脚脚型	弯脚脚型				
STE-20D180K	23.0	4.0	10.0	1.0	0.7			√	√
STE-20D220K	23.0	4.0	10.0	1.0	0.7			√	√
STE-20D270K	23.0	4.5	10.0	1.0	0.7			√	√
STE-20D330K	23.0	4.5	10.0	1.0	0.7			√	√
STE-20D390K	23.0	4.5	10.0	1.0	0.7			√	√
STE-20D470K	23.0	5.0	10.0	1.0	0.7			√	√
STE-20D560K	23.0	5.0	10.0	1.0	0.7			√	√
STE-20D680K	23.0	5.5	10.0	1.0	0.7			√	√
STE-20D820K	23.0	4.0	10.0	1.0	0.7	√	√	√	√
STE-20D101K	23.0	4.5	10.0	1.0	0.7	√	√	√	√
STE-20D121K	23.0	4.5	10.0	1.0	0.7	√	√	√	√
规格	尺寸 (mm)					安规认证			

	D Max.	T Max.	F±0.8	d±0.05		CQC	VDE	UL (美国)	cUL (加拿大)
				直脚脚型	弯脚脚型				
STE-20D151K	23.0	5.0	10.0	1.0	0.7	√	√	√	√
STE-20D181K	23.0	5.0	10.0	1.0	0.7	√	√	√	√
STE-20D201K	23.0	5.0	10.0	1.0	0.7	√	√	√	√
STE-20D221K	23.0	5.5	10.0	1.0	0.7	√	√	√	√
STE-20D241K	23.0	5.0	10.0	1.0	0.7	√	√	√	√
STE-20D271K	23.0	5.0	10.0	1.0	0.7	√	√	√	√
STE-20D301K	23.0	5.5	10.0	1.0	0.7	√	√	√	√
STE-20D331K	23.0	5.5	10.0	1.0	0.7	√	√	√	√
STE-20D361K	23.0	5.5	10.0	1.0	0.7	√	√	√	√
STE-20D391K	23.0	5.5	10.0	1.0	0.7	√	√	√	√
STE-20D431K	23.0	5.5	10.0	1.0	0.7	√	√	√	√
STE-20D471K	23.0	5.5	10.0	1.0	0.7	√	√	√	√
STE-20D511K	23.0	5.5	10.0	1.0	0.7	√	√	√	√
STE-20D561K	23.0	5.5	10.0	1.0	0.7	√	√	√	√
STE-20D621K	23.0	6.0	10.0	1.0	0.7	√	√	√	√
STE-20D681K	23.0	6.0	10.0	1.0	0.7	√	√	√	√
STE-20D751K	23.0	6.5	10.0	1.0	0.7	√	√	√	√
STE-20D781K	23.0	6.5	10.0	1.0	0.7			√	√
STE-20D821K	23.0	7.0	10.0	1.0	0.7	√	√	√	√
STE-20D911K	23.0	7.0	10.0	1.0	0.7	√	√	√	√
STE-20D102K	23.0	7.5	10.0	1.0	0.7	√	√	√	√
STE-20D112K	23.0	7.5	10.0	1.0	0.7	√		√	√

脚型、脚长说明

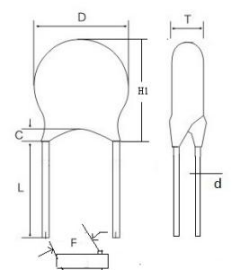
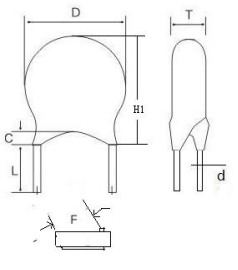
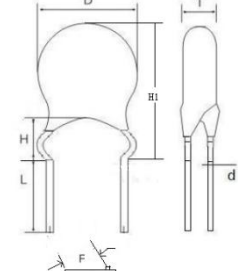
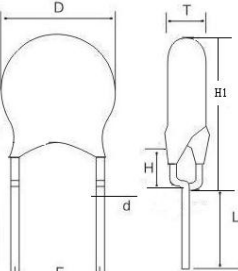
脚型	图示	脚长 L (mm)	包封脚长 C (mm)	高度 H (mm)
长直脚脚型		16.0 min	3.0 Max	/
短直脚脚型		① $[2.5 \leq L < 6.0] \pm 0.5$; ② $[6.0 \leq L \leq 10] \pm 1.0$	3.0 Max	/
单外弯脚型		① $[2.5 \leq L < 6.0] \pm 0.5$; ② $[6.0 \leq L \leq 10] \pm 1.0$	包封脚不超过弯点	5.5mm Max
前后翘脚型		① $[2.5 \leq L < 6.0] \pm 0.5$; ② $[6.0 \leq L \leq 10] \pm 1.0$	包封脚不超过弯点	4.5mm Max

编带尺寸 (mm)

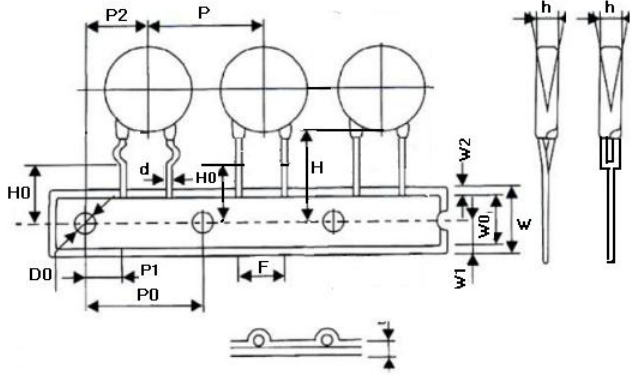
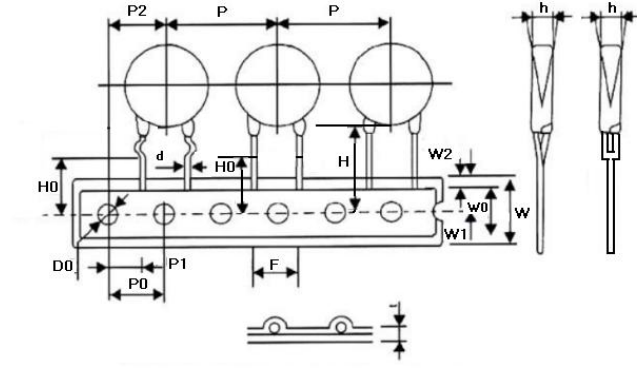
图示	Fig.1		Fig.2				
	代码	P=5.0	P=7.5		P=10.0		
 <p>Fig.1 (P=5.0)</p>	Po	12.7±0.3	12.7±0.3	12.7±0.3			
	P	12.7±1.0	25.4±1.0	25.4±1.0			
	P1	3.85±0.7	8.95±0.7	7.7±0.7			
	P2	6.35±1.3	12.7±1.3	12.7±1.3			
	F	5±0.8	7.5±0.8	10.0±0.8			
	Δh	0±2.0	0±2.0	0±2.0			
	W	18.0+1.5/-1.0	18.0 +1.5/-1.0	18.0 +1.5/-1.0			
	Wo	10.5 Max	10.5 Max	10.5 Max			
	W1	9.0+0.75/-0.5	9.0+0.75/-0.5	9.0+0.75/-0.5			
	W2	3.0 Max	3.0 Max	3.0 Max			
 <p>Fig.2 (P=7.5 & 10)</p>	Do	4.0±0.2	4.0±0.2	4.0±0.2			
	H	20+1.5/-1.0	20+1.5/-1.0	20+1.5/-1.0			
	Ho	16.5&17.0 +1.5/-1.0	16.5&17.0 +1.5/-1.0	16.5&17.0 +1.5/-1.0			
	L	直脚 脚型	弯脚 脚型	直脚 脚型	弯脚 脚型	直脚 脚型	弯脚 脚型
		11.0 Max	9.0 Max	11.0 Max	9.0 Max	11.0 Max	9.0 Max
	t1	0.5±0.2	0.5±0.2	0.5±0.2			
	t2	1.7 Max	1.7 Max	1.7 Max			